

Article number: 0102104

Description: Retaining ring J112 DIN472
Spring steel

Measures

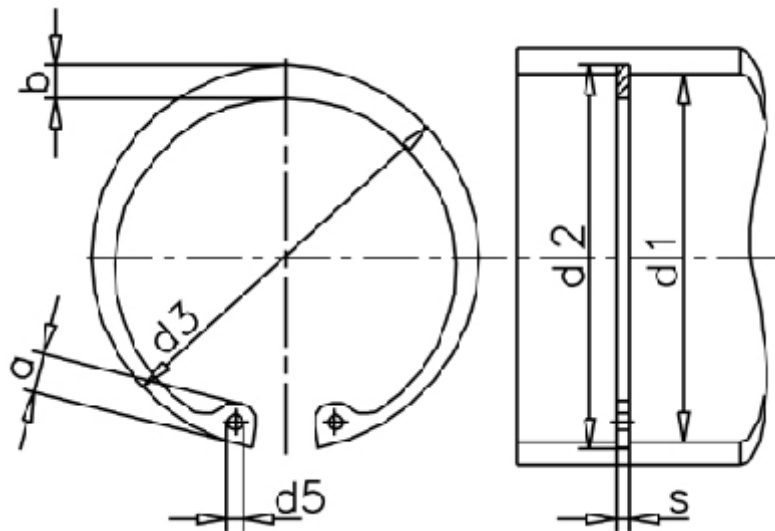

a max	= 10.5	FN kN	= 119.00	t	= 2.00
AN mm ²	= 715.0	FRg kN	= 72.0	tol	= +0,54
b	= 9.1	FR kN	= 418.0	tol	= +1,30-0,54
d1	= 112	g	= 3.0	tol	= -0.10
d2	= 116.0	K kN-mm	= 837.0	Tong	= ZGJ-4
d3	= 119.00	m min	= 4.15	Weight kg/1000	= 72.00
d5 min	= 3.5	Nominal drive	= 6.0		
Description = J 112		s	= 4.00		